



TECHNICAL DATA:

According to standard EN 1176-1:2017

Device dimensions: 0,65 x 0,05m
 Device height: 0,50m
 Foundations depth: -0,60m

The device according to EN 1176-1:2017
 Playground equipment and surfacing – Part 1:
 General safety requirements and test methods

Projection and device view

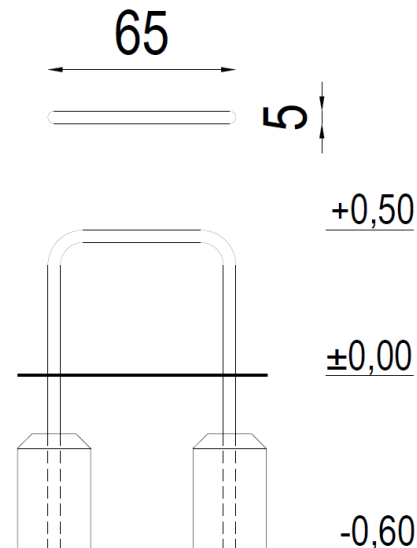

MATERIALS:

Construction: galvanized steel
 Foundations: concrete min. C12/15 standard



SATERNUS DISTRIBUTION Sp. z o.o. sp.k.
 ul. Nowa 32
 41-500 Chorzów, Poland

Certificate beholder:
 Producer:
 Distributor:

GRUPA SATERNUS Sp. z o.o. S. K. A. reserves all rights to protect copyright under the Act of February 4, 1994 on Copyright and Related Rights (Journal of Laws No. 28, pc 83), and in particular Art. 78 and 79 of this Law.

GRUPA SATERNUS Sp. z o.o. S. K. A.
 Saternus Production Sp. z o.o. sp. k.
 Saternus Distribution Sp. z o.o. sp. k.