

TECHNICAL DATA:

Easily accessible device,
according to standard EN 1176-1:2017

Device dimensions:	2,53 x 5,14m
Device height:	3,40m
Minimum space:	5,41 x 8,13m
Falling area:	32,91m ²
Critical fall height:	0,90m
Foundations depth:	-0,60m

The device according to EN 1176-1:2012
Playground equipment and surfacing – Part 1:
General safety requirements and test methods

- Safety surfaces:
- turf/topsoil, sand, gravel, bark, synthetic surface
 - minimal thickness for loose particulate materials 200+100mm
 - synthetic surface according to critical fall height

Top view with falling area

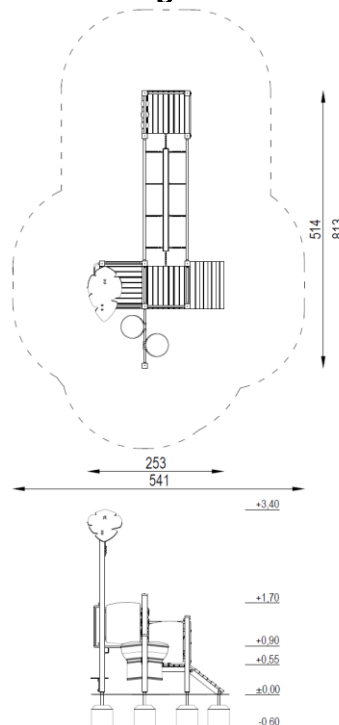

COMPONENTS:

Tower without roof, platform 55cm:	2 pcs
Tower with roof, platform 90cm:	1 pc
Entry gangplank 55cm:	1 pc
Mobile bridge:	1 pc
Balcony:	1 pc
Tic Tac Toe game:	1 pc
Small toyshop:	1 pc
Slit drum:	1 pc

MATERIALS:

Construction poles:	glued laminated pine timber, varnish painted dark brown
Anchors:	galvanized steel
Flat decorative elements:	HDPE sheets
Platforms, gangways:	impregnated pinewood boards, with machined anti-skid surface
Steel elements:	galvanized steel, powder coated
Surface of slide:	stainless steel
Ropes:	polypropylene braided with a steel, interconnected by plastic fasteners
Tic tac toe:	polypropylene rolls, painted in the screen printing technique
Drums:	rotomolded polypropylene
Caps:	plastic
Foundations:	concrete min. C12/15 standard



SATERNUS DISTRIBUTION Sp. z o.o. sp.k.
ul. Nowa 32
41-500 Chorzów, Poland

Certificate beholder:
Producer:
Distributor:

GRUPA SATERNUS Sp. z o.o. S. K. A. reserves all rights to protect copyright under the Act of February 4, 1994 on Copyright and Related Rights (Journal of Laws No. 28, pc 83), and in particular Art. 78 and 79 of this Law.

GRUPA SATERNUS Sp. z o.o. S. K. A.
Saternus Production Sp. z o.o. sp. k.
Saternus Distribution Sp. z o.o. sp. k.